



SARMAT



Machines for repairing worn holes in heavy equipment



SARMAT.PRO

Portable machines for repairing worn holes in heavy equipment

We have been manufacturing portable line boring and overlay welding machines since 2016. During this time, the Sarmat company's machines were shipped to all regions of Russia, as well as to Kazakhstan, Belarus, Ukraine, Estonia, Uzbekistan and Egypt.

When choosing machines manufactured by the Sarmat company, be sure that we will:

- manufacture this equipment in our assembling workshop;
- ship machine, ready to work, complete with all the necessary equipment and tools;
- modify the machine according to your needs in just 5 days;
- promptly send the machine, as all the equipment is in stock;
- offer you convenient payment terms;
- provide a 1-year warranty for the machine as well as post-warranty service;
- teach you how to work on machines for free and back it up with a certificate;
- provide you with free advisory assistance during the entire period of cooperation;
- offer additional equipment at a favorable price: cutters, plates, stands, drills, measuring tools, etc.

Every day we work to make our machines even better and more affordable to customers. We are proud that our machines are highly appreciated at industry exhibitions and competitions.



Pioneer Portable Line Boring Machine

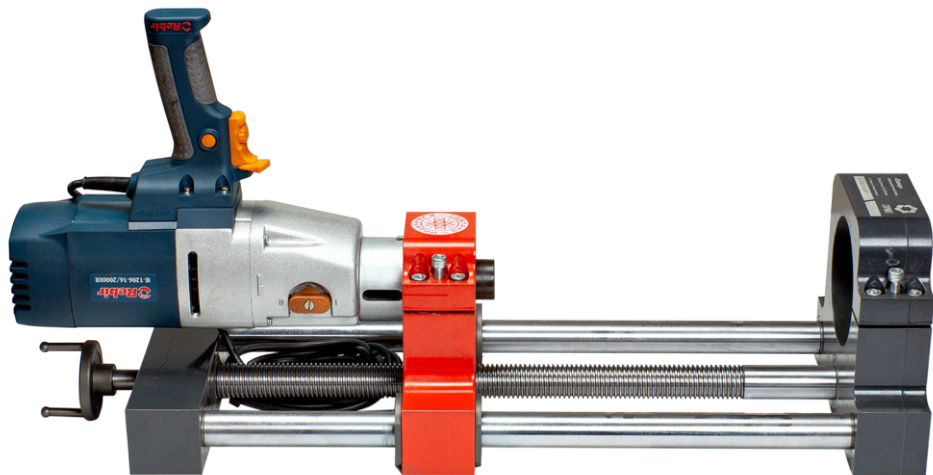

Specifications:

Boring diameter	44-200 mm (boring diameter can be from 30 mm)
Boring bar	Operating stroke - 400 mm, diameter - 30 mm, length - 1200 mm*
Drive	Electric drill (high-torque)
Feed	Manual
Max. boring length	Unlimited (depends on the boring bar length)
Power	220 V
Frequency	50 Hz
Weight	20 kg
Roughness	Ra 1.6
Dimensions (LxHxW)	750x200x230 mm

* by prior agreement with the customer, it is possible to install a boring bar of any length.

Application fields of the Pioneer Portable Line Boring Machine:

- Simultaneous line boring of several holes distanced from each other;
- Restoration of seats for bearing races of gearboxes, machine beds and other housings;
- Repair of worn straight holes of road-building, quarry, mine, municipal engineering vehicles and equipment;
 - Repair of worn straight holes of rolling mills and conveyors used at the heavy and metallurgical industry enterprises;
 - Repair of worn straight holes of equipment used in the production, processing and transportation of raw hydrocarbons (oil, gas and their fractions);
 - Repair of units of hydraulic structures (units of sluices, drawbridges, etc.).

Advantages:

- The most affordable machine in the Sarmat product line of line boring machines.
- The machine is always in stock.
- It is possible to re-equip Pioneer Line Boring Machine with Pioneer RNK parts.
- It is possible to modify the machine in accordance with the customer's requirements.
- It is possible to re-equip Pioneer Line Boring Machine with Pioneer Auto parts (automatic feed unit, remote control, control station).

Pioneer Auto Portable Line Boring Machine

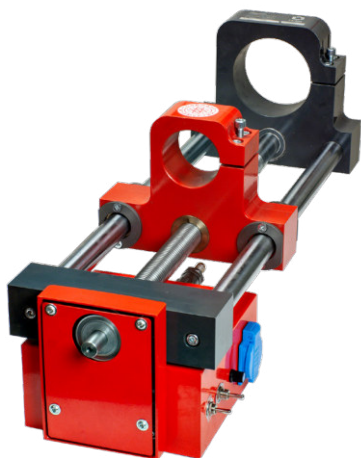
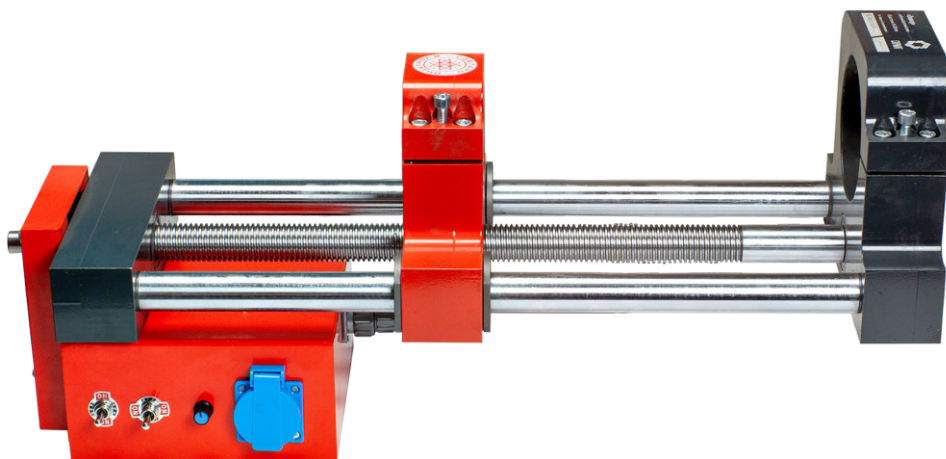

Specifications:

Boring diameter	44-200 mm (boring diameter can be from 30 mm)
Boring bar	Operating stroke - 400 mm, diameter - 30 mm, length - 1200 mm*
Drive	Electric drill (high-torque)
Feed	Automatic
Max. boring length	Unlimited (depends on the boring bar length)
Power	220 V
Frequency	50 Hz
Accuracy	H7
Remote control	On/Off, boring bar direction switch, boring bar feed rate adjustment
Suspended control station	On/Off, boring bar direction switch, boring bar feed rate adjustment
Dimensions (LxHxW)	705x310x230 mm
Weight	26 kg

* by prior agreement with the customer, it is possible to install a boring bar of any length.

Application fields of the Pioneer Auto Portable Line Boring Machine:

- Simultaneous line boring of several holes distanced from each other;
- Restoration of seats for bearing races of gearboxes, machine beds and other housings;
- Repair of worn straight holes of road-building, quarry, mine, municipal engineering vehicles and equipment;
 - Repair of worn straight holes of rolling mills and conveyors used at the heavy and metallurgical industry enterprises;
 - Repair of worn straight holes of equipment used in the production, processing and transportation of raw hydrocarbons (oil, gas and their fractions);
 - Repair of units of hydraulic structures (units of sluices, drawbridges, etc.).

It is possible to re-equip Pioneer Line Boring Machine with Pioneer Auto parts (automatic feed unit, remote control, control station).

Pioneer 2 Portable Line Boring Machine

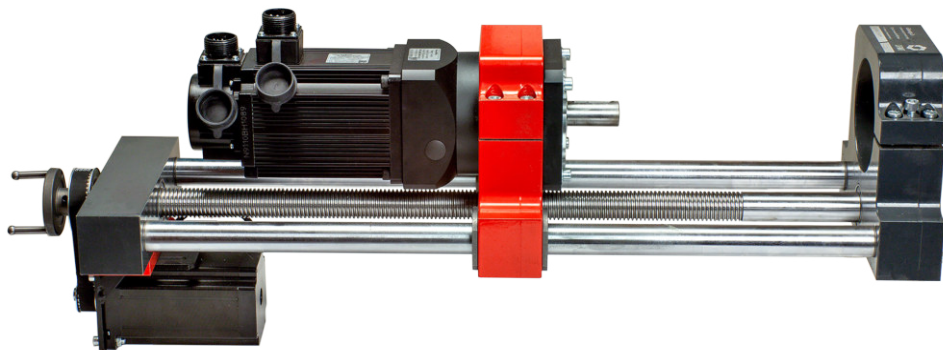

Specifications:

Boring diameter	54-400 mm (boring diameter can be from 30-600 mm)
Boring bar	Operating stroke - 500 mm, diameter - 40 mm, length - 1500 mm*
Drive	Servo motor with encoder and planetary gear reducer
Feed	Automatic with 0-1.0 mm/rev rate
Max. boring length	Unlimited (depends on the boring bar length)
Rotation rate	0-300 rpm
Feed adjustment	Smooth, stepless
Power	220 V
Frequency	50 Hz
Weight	40 kg
Accuracy	H7
Remote control	On/Off, direction switch, boring bar feed and rotation rate adjustment, stop
Control station (IP64 metal case)	On/Off switch, Electric main indicator, Emergency stop key button, Start key button, Reset indicator button
Dimensions (LxHxW)	900x350x230 mm

* by prior agreement with the customer, it is possible to install a boring bar of any length.

Advantages of the machine:

- Maximum boring diameter in our line boring machines production line.
- Remote control.
- Modification in accordance with the customer's requirements.
- Easy mounting of the machine due to its low weight by only one specialist.

Additional functions:

- Wireless bluetooth control via Android device app.
- IP64 impact-proof wheeled plastic case for the control station.

Pioneer 2 Portable Line Boring Machine is used for boring holes with a diameter from 54 to 400 mm and a depth of 500 mm per one run. For further boring, it is enough to change the position of the boring cutter.

Pioneer 3 Portable Line Boring Machine

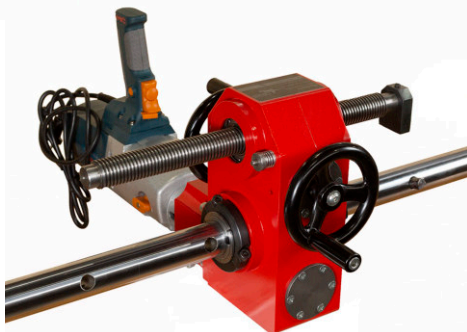
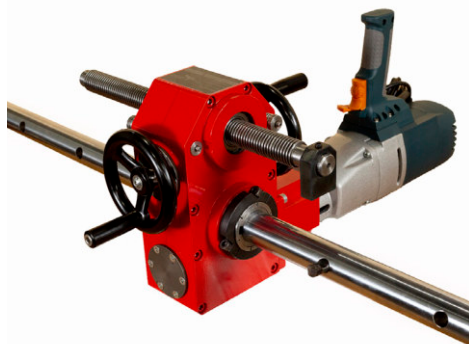
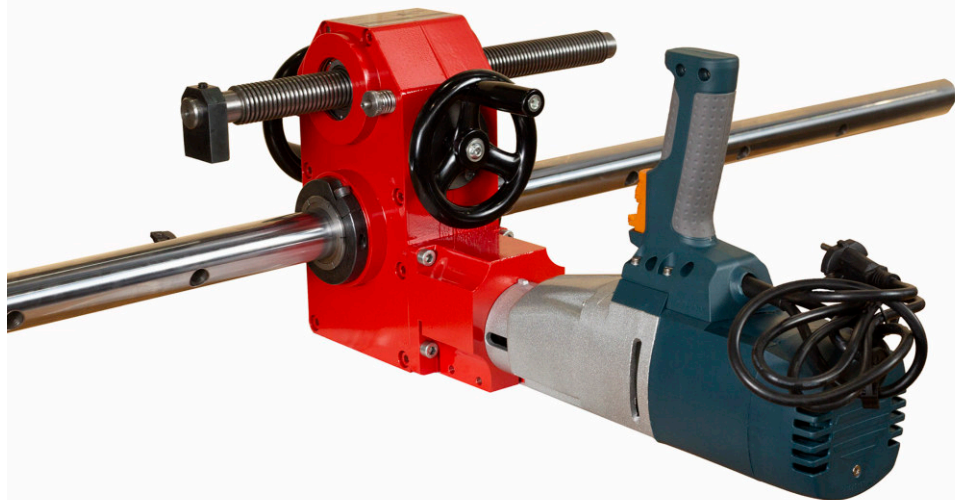

Specifications:

Boring diameter	64-400 mm
Boring bar	Operating stroke - unlimited, diameter - 50 mm, length - 1500 mm*
Stroke	Unlimited (depends on the leadscrew length)
Drive	Electric drill (high-torque)
Leadscrew length	300 mm (any length is possible)
Max. boring length	Unlimited (depends on the boring bar length)
Rotation rate	Depends on the electric drill
Feed adjustment	Smooth, stepless
Feed rate	0-0.29 mm/rev
Power	220 V
Frequency	50 Hz
Weight	15 kg
Accuracy	H7
Dimensions (LxHxW)	94x210x141 mm

** by prior agreement with the customer, it is possible to install a boring bar of any length*

Advantages of the machine:

- Small size allows operation in confined spaces.
- Easy to operate.
- One drive for feed and rotation.
- Unlimited operational stroke.
- Mounting in any spatial position.
- No electric components.
- Designed to work aloft as well as in fields, forests, mines, quarries and open-pit mines.
- Easy mounting of the machine due to its low weight by only one specialist.
- Mechanical feed rate adjustment, mechanical feed direction switch, manual feed.
- It is possible to use a hydraulic motor as a feed for the boring bar rotation. The machine will be additionally equipped with a hydraulic power unit.

Sarmat NK 450 Portable Overlay Welding Machine

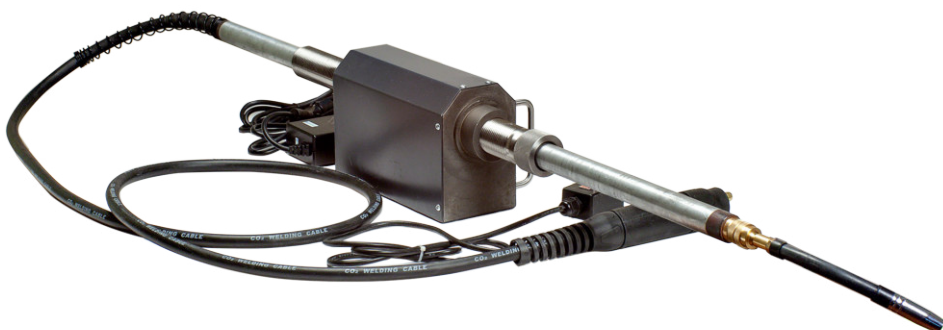

Specifications:

Welding diameter	30-400 mm (can be reached up to 1000 mm)
Welding bar diameter	30 mm
Welding bar length	1000 mm
Operating stroke	208 mm
Rotation stroke	0-4 rev/min
Feed rate	0-12 mm/min
Feed reverse	Available
Welding hose	3 m
Rod diameter	0.8-1.2 mm
Connector of the welding hose	Euro connector
Welding type	MIG (semi-automatic)
Feed and rotation rate adjustment	Smooth, stepless
Overload protection	Available
Power	220 V
Frequency	50 Hz
Dimensions (LxHxW)	275x155x155 mm
Weight	7 kg

Application fields of the Sarmat NK 450 Machine:

The machine is used for welding of internal surfaces of worn holes. In order to eliminate the ellipsoidal configuration of the hole, it is necessary to use a line boring machine, and then to carry out the overlay welding. At this very stage it is necessary to use an overlay welding machine. After that it's possible to perform a finish boring and to achieve the original size.

Advantages of the machine:

- Easy mounting of the machine due to its low weight by only one specialist.
- Easy to operate and to mount.
- Possibility to mount on main support of the Pioneer machines.

Sarmat NK 750 Portable Overlay Welding Machine



Specifications:

Internal welding diameter	30-400 mm (can be reached up to 1000 mm)
Frontal welding diameter	20-500 mm (can be reached up to 1000 mm)
External welding diameter	20-750 mm (can be reached up to 1000 mm)
Welding bar	Diameter - 30 mm, length - 1000 mm
Operating stroke	208 mm
Rotation rate	0-4 rev/min
Feed rate	0-12 mm/min
Feed reverse	Available
Welding hose	3 m
Rod diameter	0.8-1.2 mm
Connector of the welding hose	Euro connector
Welding type	MIG (semi-automatic)
Feed and rotation rate adjustment	Smooth, stepless
Overload protection	Available
Power	220 V
Frequency	50 Hz
Dimensions (LxHxW)	275x155x155 mm
Weight	7 kg

Application fields of the Sarmat NK 750 Machine:

The machine is used for welding of internal, external and frontal surfaces of worn holes. In order to eliminate the ellipsoidal configuration of the hole, it is necessary to use line boring machine, then to carry out the overlay welding. At this very stage it is necessary to use an overlay welding machine. Unlike Sarmat NK 450, Portable Overlay Welding Machine Sarmat NK 750 performs not only internal overlay welding, but also external and frontal overlay welding.

Advantages of the machine:

- Easy mounting of the machine due to its low weight by only one specialist.
- Easy to operate.
- It speeds the restoration of worn holes up and simplifies it.

Pioneer 4 Portable Line Boring and Overlay Welding Machine

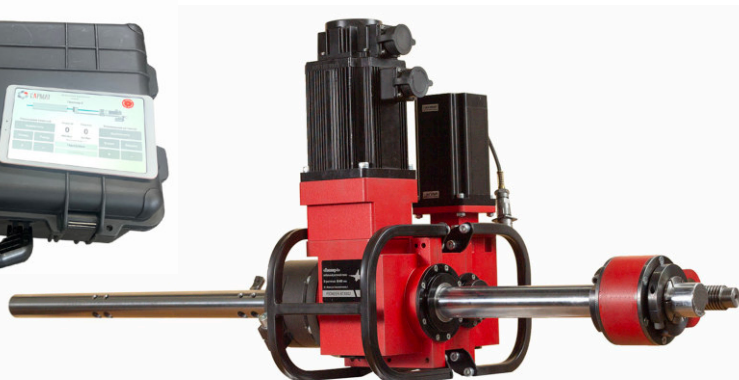
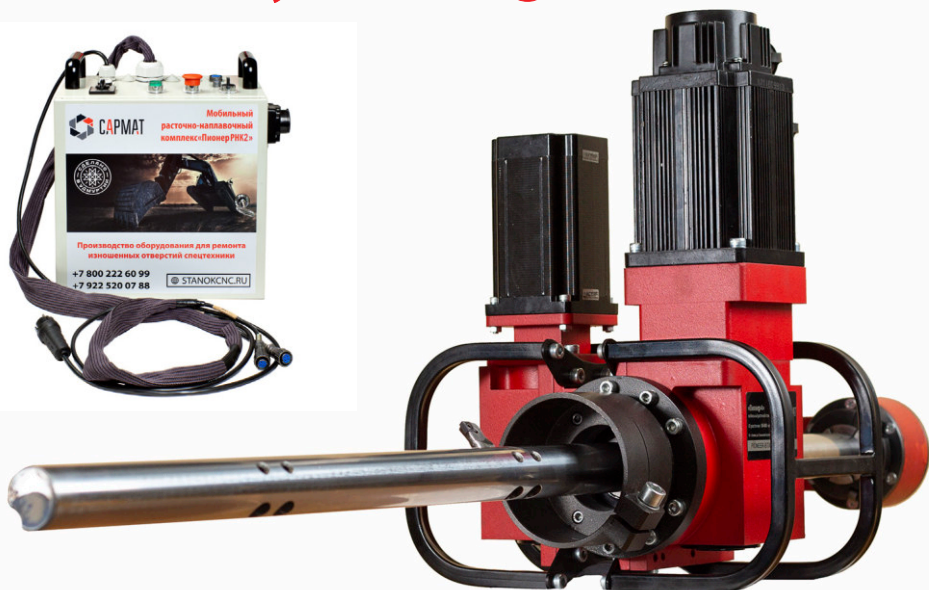

Specifications:

Boring diameter	54-400 mm
Welding diameter	54-400 mm
Boring bar	Operating stroke - unlimited, diameter - 40 mm, length - 1500 mm*
Welding bar	Diameter - 40 mm, length - 1000 mm
Leadscrew length	300 mm
Drive	1.5 kW servo motor
Feed drive	0.8 kW step motor
Rotation rate	0-200 rpm
Feed adjustment	Smooth, stepless
Feed rate	0-36 mm/min
Power	220 V
Frequency	50 Hz
Machine weight/ package weight	25 kg/ 120 kg
Accuracy	H7
Remote control	On/Off, direction switch, boring bar feed and rotation rate adjustment, stop
Control station (IP64 metal case)	On/Off switch, Electric main indicator, Emergency stop key button, Start key button, Reset key button
Wireless control	via Android device app*
Dimensions (LxHxW)	180x465x355 mm

*additional option

Advantages of the machine:

- Small size allows to operate in confined spaces, easy to operate.
- One drive for feed and rotation, no electric components.
- Mounting in any spatial position.
- Designed to work aloft as well as in fields, forests, mines, quarries and open-pit mines.
- Easy mounting due to its low weight by only one specialist.
- Mechanical feed rate adjustment, mechanical feed direction switch, manual feed.
- It is possible to use a hydraulic motor as a feed for the boring bar rotation. The machine will be additionally equipped with a hydraulic power unit.

Additional functions:

- Wireless bluetooth control via Android device app.
- IP64 impact-proof wheeled plastic case for the control station.

RNK Portable Line Boring and Overlay Welding Machine



Specifications:

Boring diameter	44-200 mm (boring diameter can be from 30 mm)
Welding diameter	30-200 mm
Boring bar	Diameter - 30 mm, length - 1200 mm
Welding Bar	Diameter - 30 mm, length - 1000 mm
Operating stroke	400 mm
Drive	electric drill
Rotation rate	0-500 rev/min
Rotation rate adjustment	Smooth, stepless
Feed drive	0.8 kW step motor
Feed rate	0-1.0 mm/rev
Feed rate adjustment	Smooth, stepless
Welding bar feed drive	0.8 kW step motor
Max. boring length	Unlimited (depends on the boring bar length)
Welding modes	Automatic/manual
Remote control	On/Off switch for the machine and for the semiautomatic welding machine, direction switch for feed and rotation of the welding bar, adjustment of the boring bar feed rate and welding bar rotation rate
Control station (IP64 metal case)	On/Off switch, Electric main indicator, Emergency stop key button, Start key button, Reset key button, Modes switch 'boring-welding'
Power	220 V, 50 Hz
Dimensions (LxHxW)	750x340x230 mm
Weight	25 kg

Application fields of the Machine:

Pioneer RNK is designed to repair worn holes of heavy equipment on-site. One machine is used both for boring and welding.

The work is performed in three stages:

1. Line boring of a worn hole to eliminate the ellipsoidal configuration of the hole.
2. Overlay welding to restore the metal layer.
3. Final line boring up to the right size.

RNK 2 Portable Line Boring and Overlay Welding Machine

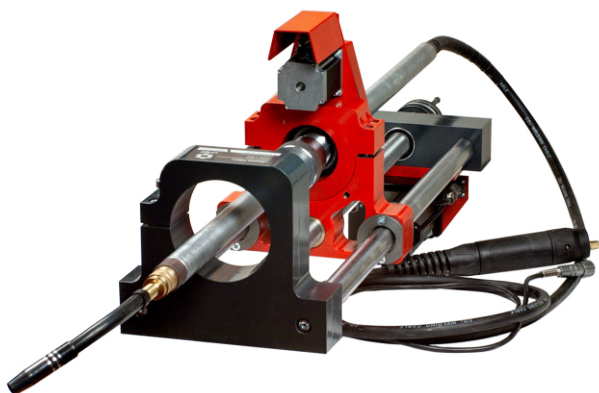
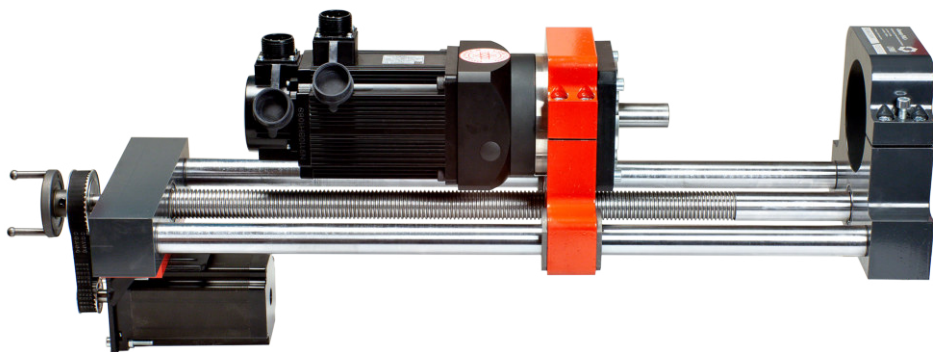

Specifications:

Boring diameter	54-400 mm (boring diameter can be from 30 mm)
Welding diameter	30-400 mm
Boring bar	Diameter - 40 mm, length - 1500 mm
Operating stroke	500 mm
Welding bar	Diameter - 30 mm, length - 1000 mm
Operating stroke of the welding bar	500 mm
Rotation rate	0-300 rpm
Rotation rate adjustment	Smooth, stepless
Feed drive	0.8 kW step motor
Feed rate	0-1.0 mm/rev
Feed rate adjustment	Smooth, stepless
Feed drive of the welding bar	0.8 kW step motor
Max. boring length	Unlimited (depends on the boring bar length)
Welding modes	Automatic, continuous/manual
Remote control	On/Off switch for the machine and for the semiautomatic welding machine, direction switch for feed and rotation of the welding bar, adjustment of the boring bar feed rate and welding bar rotation rate
Control station (IP64 metal case)	On/Off switch, Electric main indicator, Emergency stop key button, Start key button, Reset key button, Modes switch 'boring-welding'
Power	220 V, 50 Hz
Dimensions (LxHxW)	900x350x230 mm
Weight	40 kg

Application fields of the Machine:

Pioneer RNK 2 is designed to repair worn holes of heavy equipment on-site. One machine is used both for boring and welding.

Additional functions:

- Wireless bluetooth control via Android device app.
- IP64 impact-proof wheeled plastic case for the control station.

Sarmat GRS Portable Line Boring Machine

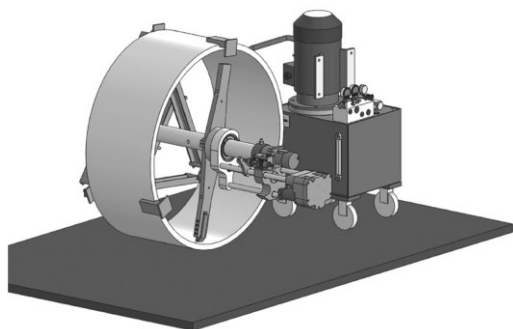

Specifications:

Boring diameter: 500 - 800 mm.
Boring bar: operating stroke - 350 mm,
diameter 100x10 mm.
Rotation rate: 35-50 rpm.
Feed and rotary drive: hydraulic motor.
Hydraulic power unit: 380 V, 50 Hz.
Feed rate: 1.85 - 16 mm/min.

Application fields of the Machine:

- Simultaneous line boring of several holes distanced from each other;
- Repair of worn straight holes of equipment used in the production, processing and transportation of raw hydrocarbons (oil, gas and their fractions); road-building, quarry, mine, municipal engineering vehicles and equipment; rolling mills and conveyors used at the heavy and metallurgical industry enterprises;
- Repair of hydraulic structures units (units of sluices, drawbridges, etc.)

Sarmat PRS TD 250 Portable Line Boring Machine

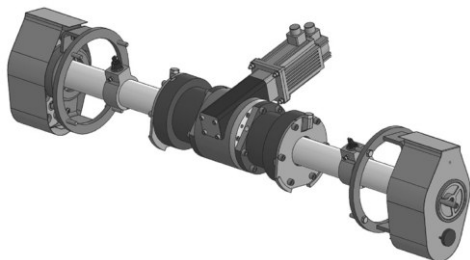

Parameters of the Machine:

Boring diameter: 200 - 250 mm.
Boring bar: operating stroke - 290 mm,
diameter - 80 mm.
Rotation rate: 0 - 150 rpm.
Drive power: 1.5 kW; 220 V, 50 Hz.

Application fields of the Machine:

- Maintenance services and current maintenance of mechanical sections of electric locomotives.
- Line boring of inner race of motor suspension bearing and line boring of motor suspension bearing seats of driving motor frame.

When the heavy equipment is in service, metal galling occurs. This process leads to both natural abrasive wear of metal and to a dimensional change of holes. As a result, the equipment breaks down.

Portable line boring machines and portable overlay welding machines repair such worn holes and restore their original sizes. The main advantage of such machines is their portability.

Now you can significantly reduce time and cost of the repair works as there is no need to transport your equipment to the repair shop. Portable line boring machines and portable overlay welding machines allow direct on-site repair without complete disassembling of the equipment.

Application of portable line boring and overlay welding machines



Sea and River Transport



Road-building Machines and Heavy Equipment



Load-carrying Transport



Railroad Transport

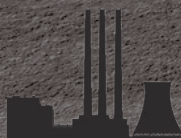

Electric-power Industry



Oil and Gas



Agricultural Industry



Special-purpose machines



SARMAT

1, Golyanskiy Posyolok street, Izhevsk,
Russian Federation

+7 922 521 74 74, +7 922 500 55 33

export@stanokcnc.ru



SARMAT.PRO